

# Infinite System Specification

## — Curve series



MS3535D-A90  
MS5035D-A90  
MS7035D-A90  
MS3535P-A90  
MS5035P-A90  
MS7035P-A90



Optical: Diffuser

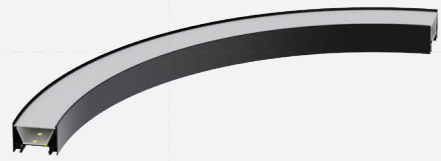

Optical: Prismatic

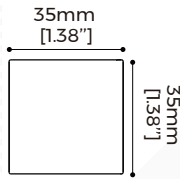

Model:  
MS3535D-A90  
MS3535P-A90

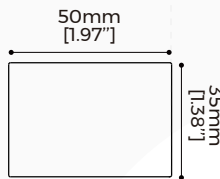

Model:  
MS5035D-A90  
MS5035P-A90

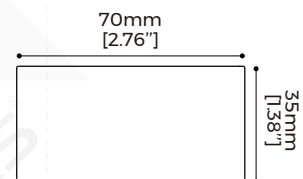

Model:  
MS7035D-A90  
MS7035P-A90

## Basic Information

### Light efficiency

<b>MS3535D-A90</b> 100LM/W(Regular), 120LM/W(High-Efficiency)	<b>MS3535P-A90</b> 85LM/W(Regular), 105LM/W(High-Efficiency)
<b>MS5035D-A90</b> 100LM/W(Regular), 120LM/W(High-Efficiency)	<b>MS5035P-A90</b> 90LM/W(Regular), 105LM/W(High-Efficiency)
<b>MS7035D-A90</b> 110LM/W(Regular), 135LM/W(High-Efficiency)	<b>MS7035P-A90</b> 100LM/W(Regular), 120LM/W(High-Efficiency)

### Diameter

<b>MS3535D-A90/MS3535P-A90/MS5035D-A90/MS5035P-A90</b> D450/600/800/1000/1200/1500/2000/3000 mm	<b>MS7035D-A90/MS7035P-A90</b> 600/800/1000/1200/1500/2000/3000 mm
--	---

### Common information

· Material:	AL6063-T5, spraying surface
· Color:	Black/White/Silver/Orange/Blue/Green /Rose gold/Champagne gold
· IP grade:	IP20
· CCT:	2700/3000/3500/4000/5000/6500K
· CRI:	>80/>90
· SDCM:	≤3 Step
· Dimming method:	Non-dimming, 1-10V, DALI2+PUSH
· Application:	Indoor
· Installation:	Ceiling/Pendant
· Certification:	CE, UKCA, ROHS, REACH, CB, ENEC, ETL, LM-80
· Warranty:	5 years

## © Product Dimension Information

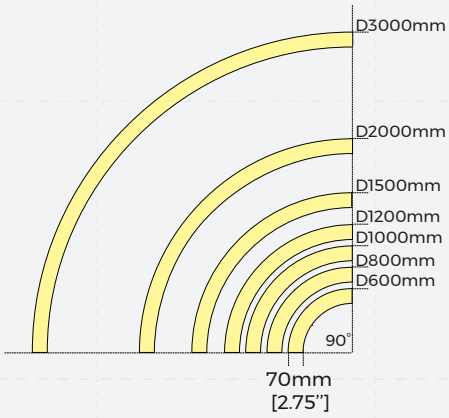
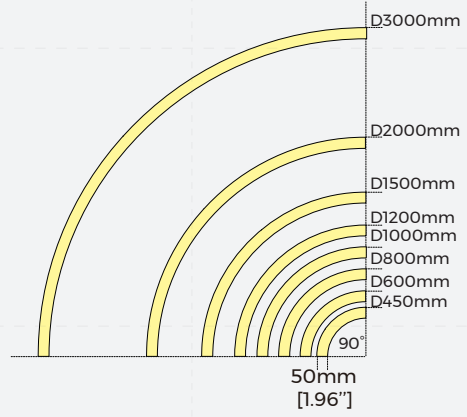
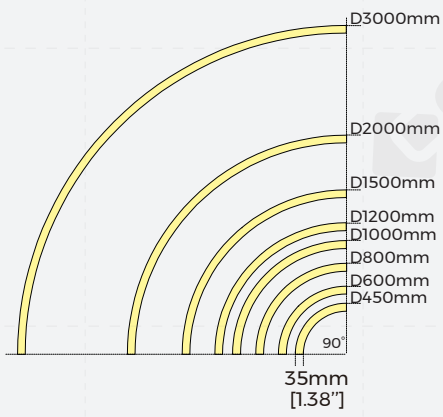

\*The yellow fill means luminous surface.

© Luminaire Parameters

Model	Version	Diameter (mm)	Angle (°)	Type Power (W/PCS)	Input Voltage (V)	Input Current (A)	CRI	Lumens (LM/PCS)	CCT
MS3535D-A90	Regular	D450 [1.48ft]	90°	6.3	DC36V	0.16	>80	633	2700K 3000K 3500K 4000K 5000K 6500K
							>90	544	
		D600 [1.97ft]	90°	9	DC36V	0.225	>80	890	
							>90	765	
		D800 [2.62ft]	90°	12	DC36V	0.3	>80	1186	
							>90	1020	
		D1000 [3.28ft]	90°	15	DC36V	0.375	>80	1483	
							>90	1275	
		D1200 [3.94ft]	90°	18	DC36V	0.45	>80	1779	
							>90	1530	
		D1500 [4.92ft]	90°	24	DC36V	0.6	>80	2372	
							>90	2040	
	D2000 [6.56ft]	90°	32	DC36V	0.8	>80	3163		
						>90	2720		
	D3000 [9.84ft]	90°	47	DC36V	1.2	>80	4744		
						>90	4080		
	High-Efficiency	D450 [1.48ft]	90°	6.3	DC36V	0.16	>80	759	
							>90	653	
		D600 [1.97ft]	90°	9	DC36V	0.225	>80	1067	
							>90	918	
		D800 [2.62ft]	90°	12	DC36V	0.3	>80	1423	
							>90	1224	
		D1000 [3.28ft]	90°	15	DC36V	0.375	>80	1779	
							>90	1530	
D1200 [3.94ft]		90°	18	DC36V	0.45	>80	2135		
						>90	1836		
D1500 [4.92ft]		90°	24	DC36V	0.6	>80	2847		
						>90	2448		
D2000 [6.56ft]	90°	32	DC36V	0.8	>80	3795			
					>90	3264			
D3000 [9.84ft]	90°	47	DC36V	1.2	>80	5693			
					>90	4896			

Model	Version	Diameter (mm)	Angle (°)	Type Power (W/PCS)	Input Voltage (V)	Input Current (A)	CRI	Lumens (LM/PCS)	CCT
MS3535P-A90	Regular	D450 [1.48ft]	90°	6.3	DC36V	0.16	>80	538	2700K 3000K 3500K 4000K 5000K 6500K
							>90	462	
		D600 [1.97ft]	90°	9	DC36V	0.225	>80	756	
							>90	650	
		D800 [2.62ft]	90°	12	DC36V	0.3	>80	1008	
							>90	867	
		D1000 [3.28ft]	90°	15	DC36V	0.375	>80	1260	
							>90	1084	
		D1200 [3.94ft]	90°	18	DC36V	0.45	>80	1512	
							>90	1301	
		D1500 [4.92ft]	90°	24	DC36V	0.6	>80	2016	
							>90	1734	
	D2000 [6.56ft]	90°	32	DC36V	0.8	>80	2688		
						>90	2312		
	D3000 [9.84ft]	90°	47	DC36V	1.2	>80	4033		
						>90	3468		
	High-Efficiency	D450 [1.48ft]	90°	6.3	DC36V	0.16	>80	664	
							>90	571	
		D600 [1.97ft]	90°	9	DC36V	0.225	>80	934	
							>90	803	
		D800 [2.62ft]	90°	12	DC36V	0.3	>80	1245	
							>90	1071	
		D1000 [3.28ft]	90°	15	DC36V	0.375	>80	1557	
							>90	1339	
D1200 [3.94ft]		90°	18	DC36V	0.45	>80	1868		
						>90	1607		
D1500 [4.92ft]		90°	24	DC36V	0.6	>80	2491		
						>90	2142		
D2000 [6.56ft]	90°	32	DC36V	0.8	>80	3321			
					>90	2856			
D3000 [9.84ft]	90°	47	DC36V	1.2	>80	4981			
					>90	4284			

Model	Version	Diameter (mm)	Angle (°)	Type Power (W/PCS)	Input Voltage (V)	Input Current (A)	CRI	Lumens (LM/PCS)	CCT
MS5035D-A90	Regular	D450 [1.48ft]	90°	7.4	DC36V	0.187	>80	739	2700K 3000K 3500K 4000K 5000K 6500K
							>90	636	
		D600 [1.97ft]	90°	11	DC36V	0.28	>80	1107	
							>90	952	
		D800 [2.62ft]	90°	14	DC36V	0.35	>80	1384	
							>90	1190	
		D1000 [3.28ft]	90°	18	DC36V	0.45	>80	1779	
							>90	1530	
	D1200 [3.94ft]	90°	22	DC36V	0.56	>80	2214		
						>90	1904		
	D1500 [4.92ft]	90°	28	DC36V	0.7	>80	2767		
						>90	2380		
	D2000 [6.56ft]	90°	36	DC36V	0.9	>80	3558		
						>90	3060		
	D3000 [9.84ft]	90°	53	DC36V	1.35	>80	5337		
						>90	4590		
High-Efficiency	D450 [1.48ft]	90°	7.4	DC36V	0.187	>80	887		
						>90	763		
	D600 [1.97ft]	90°	11	DC36V	0.28	>80	1328		
						>90	1142		
	D800 [2.62ft]	90°	14	DC36V	0.35	>80	1660		
						>90	1428		
	D1000 [3.28ft]	90°	18	DC36V	0.45	>80	2135		
						>90	1836		
D1200 [3.94ft]	90°	22	DC36V	0.56	>80	2657			
					>90	2285			
D1500 [4.92ft]	90°	28	DC36V	0.7	>80	3321			
					>90	2856			
D2000 [6.56ft]	90°	36	DC36V	0.9	>80	4270			
					>90	3672			
D3000 [9.84ft]	90°	53	DC36V	1.35	>80	6405			
					>90	5508			

Model	Version	Diameter (mm)	Angle (°)	Type Power (W/PCS)	Input Voltage (V)	Input Current (A)	CRI	Lumens (LM/PCS)	CCT
MS5035P-A90	Regular	D450 [1.48ft]	90°	7.4	DC36V	0.187	>80	665	2700K 3000K 3500K 4000K 5000K 6500K
							>90	572	
		D600 [1.97ft]	90°	11	DC36V	0.28	>80	996	
							>90	857	
		D800 [2.62ft]	90°	14	DC36V	0.35	>80	1245	
							>90	1071	
		D1000 [3.28ft]	90°	18	DC36V	0.45	>80	1601	
							>90	1377	
		D1200 [3.94ft]	90°	22	DC36V	0.56	>80	1993	
							>90	1714	
		D1500 [4.92ft]	90°	28	DC36V	0.7	>80	2491	
							>90	2142	
	D2000 [6.56ft]	90°	36	DC36V	0.9	>80	3202		
						>90	2754		
	D3000 [9.84ft]	90°	53	DC36V	1.35	>80	4803		
						>90	4131		
	High-Efficiency	D450 [1.48ft]	90°	7.4	DC36V	0.187	>80	776	
							>90	668	
		D600 [1.97ft]	90°	11	DC36V	0.28	>80	1162	
							>90	1000	
		D800 [2.62ft]	90°	14	DC36V	0.35	>80	1453	
							>90	1250	
		D1000 [3.28ft]	90°	18	DC36V	0.45	>80	1868	
							>90	1607	
D1200 [3.94ft]		90°	22	DC36V	0.56	>80	2325		
						>90	1999		
D1500 [4.92ft]		90°	28	DC36V	0.7	>80	2906		
						>90	2499		
D2000 [6.56ft]	90°	36	DC36V	0.9	>80	3736			
					>90	3213			
D3000 [9.84ft]	90°	53	DC36V	1.35	>80	5604			
					>90	4820			

Model	Version	Diameter (mm)	Angle (°)	Type Power (W/PCS)	Input Voltage (V)	Input Current (A)	CRI	Lumens (LM/PCS)	CCT
MS7035D-A90	Regular	D600 [1.97ft]	90°	14	DC36V	0.35	>80	1522	2700K 3000K 3500K 4000K 5000K 6500K
							>90	1309	
		D800 [2.62ft]	90°	22	DC36V	0.56	>80	2435	
							>90	2094	
		D1000 [3.28ft]	90°	24	DC36V	0.6	>80	2609	
							>90	2244	
		D1200 [3.94ft]	90°	30	DC36V	0.75	>80	3262	
							>90	2805	
		D1500 [4.92ft]	90°	38	DC36V	0.95	>80	4131	
							>90	3553	
		D2000 [6.56ft]	90°	49	DC36V	1.25	>80	5436	
							>90	4675	
		D3000 [9.84ft]	90°	75	DC36V	1.9	>80	8263	
							>90	7106	
	High-Efficiency	D600 [1.97ft]	90°	14	DC36V	0.35	>80	1868	
							>90	1607	
		D800 [2.62ft]	90°	22	DC36V	0.56	>80	2989	
							>90	2570	
		D1000 [3.28ft]	90°	24	DC36V	0.6	>80	3202	
							>90	2754	
		D1200 [3.94ft]	90°	30	DC36V	0.75	>80	4003	
							>90	3443	
		D1500 [4.92ft]	90°	38	DC36V	0.95	>80	5070	
							>90	4361	
D2000 [6.56ft]		90°	49	DC36V	1.25	>80	6672		
						>90	5738		
D3000 [9.84ft]		90°	75	DC36V	1.9	>80	10141		
						>90	8721		



Model	Version	Diameter (mm)	Angle (°)	Type Power (W/PCS)	Input Voltage (V)	Input Current (A)	CRI	Lumens (LM/PCS)	CCT
MS7035P-A90	Regular	D600 [1.97ft]	90°	14	DC36V	0.35	>80	1384	2700K 3000K 3500K 4000K 5000K 6500K
							>90	1190	
		D800 [2.62ft]	90°	22	DC36V	0.56	>80	2214	
							>90	1904	
		D1000 [3.28ft]	90°	24	DC36V	0.6	>80	2372	
							>90	2040	
		D1200 [3.94ft]	90°	30	DC36V	0.75	>80	2965	
							>90	2550	
		D1500 [4.92ft]	90°	38	DC36V	0.95	>80	3756	
							>90	3230	
		D2000 [6.56ft]	90°	49	DC36V	1.25	>80	4942	
							>90	4250	
		D3000 [9.84ft]	90°	75	DC36V	1.9	>80	7512	
							>90	6460	
	High-Efficiency	D600 [1.97ft]	90°	14	DC36V	0.35	>80	1660	
							>90	1428	
		D800 [2.62ft]	90°	22	DC36V	0.56	>80	2657	
							>90	2285	
		D1000 [3.28ft]	90°	24	DC36V	0.6	>80	2847	
							>90	2448	
		D1200 [3.94ft]	90°	30	DC36V	0.75	>80	3558	
							>90	3060	
		D1500 [4.92ft]	90°	38	DC36V	0.95	>80	4507	
							>90	3876	
		D2000 [6.56ft]	90°	49	DC36V	1.25	>80	5930	
							>90	5100	
		D3000 [9.84ft]	90°	75	DC36V	1.9	>80	9014	
							>90	7752	

Note:

1. The output data is based on white coated luminaire with Ra80,4000K.
2. The above Lumens data are at 4000K color temperature.
3. High-efficiency version does not do 3500K and 5000K.
4. The tolerance of output data can be vary up to 15%.
5. The type power is with the power supply, the input current is the current of the light source.
6. The output data is typical value.
7. The following is an example of lumen conversion instructions:

CCT	RA	Ratio of lumens (white coated luminaire)	Ratio of lumens (Other coated colors of luminaire)
2700K	80	90%	Calculate white coated luminaire lumens first, then multiply by 90 %
	90	77%	
3000K	80	93%	
	90	80%	
3500K	80	97%	
	90	83%	
4000K	80	100%	
	90	86%	
5000K	80	100%	
	90	86%	
6500K	80	100%	
	90	86%	

Note: All other lumens are to be based on white coated luminaire with 4000K,RA80(100%),and multiplied by the percentage in the table above.

Assuming a 4000K, RA80 white coated luminaire with 1000lm lumens:

Example 1: If you need 4000K,RA90 lumens (white coated luminaire)	$1000 \times 86\% = 860\text{lm}$
Example 2: If you need 4000K,RA90 lumens (other coated colors of luminaire)	$1000 \times 86\% \times 90\% = 774\text{lm}$
Example 3: If you need 3000K,RA80 lumens (white coated luminaire)	$1000 \times 93\% = 930\text{lm}$
Example 4: If you need 3000K,RA90 lumens (white coated luminaire)	$1000 \times 80\% = 800\text{lm}$
Example 5: If you need 5000K,RA80 lumens (white coated luminaire)	$1000 \times 100\% = 1000\text{lm}$

## © Optical Parameter

### [MS3535D-A90]

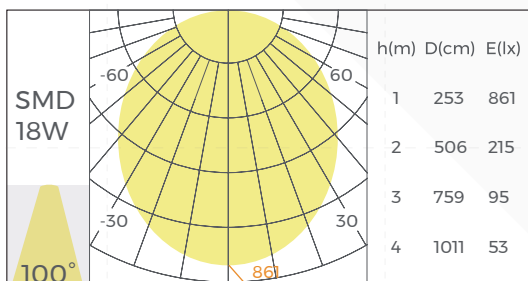

Regular version

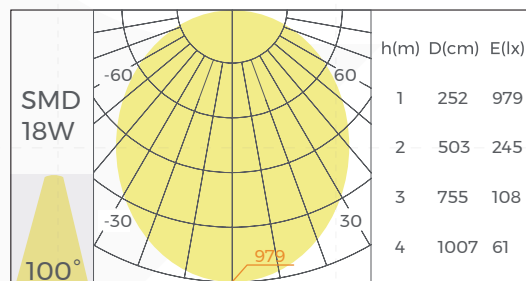

High-efficiency version

\*The above data is based on a 1200mm diameter module with Ra80,4000K.

**【MS3535P-A90】**

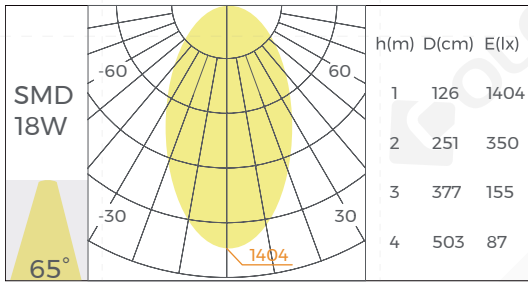

Regular version

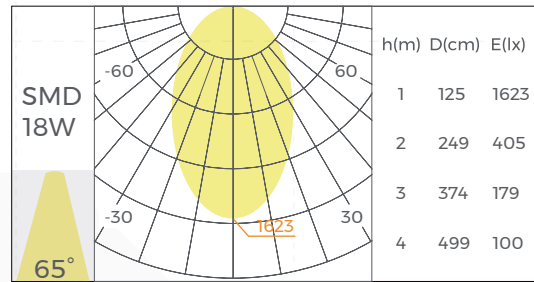

High-efficiency version

\*The above data is based on a 1200mm diameter module with Ra80,4000K.

**【MS5035D-A90】**

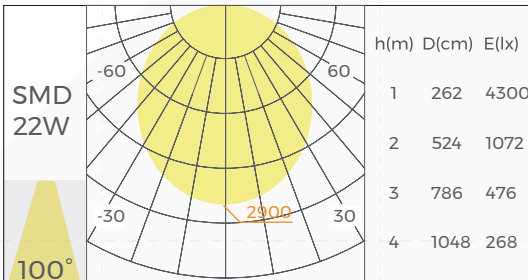

Regular version

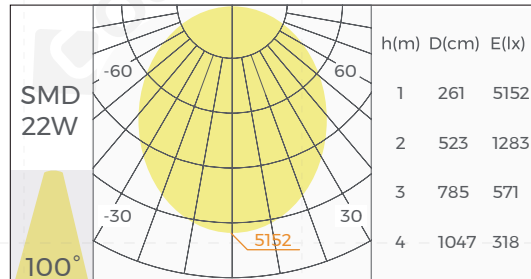

High-efficiency version

\*The above data is based on a 1200mm diameter module with Ra80,4000K.

**【MS5035P-A90】**

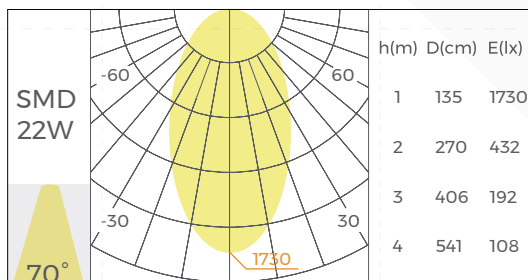

Regular version

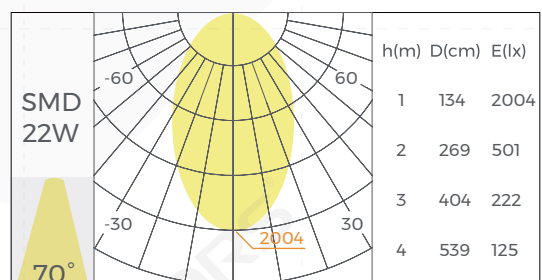

High-efficiency version

\*The above data is based on a 1200mm diameter module with Ra80,4000K.

### 【MS7035D-A90】

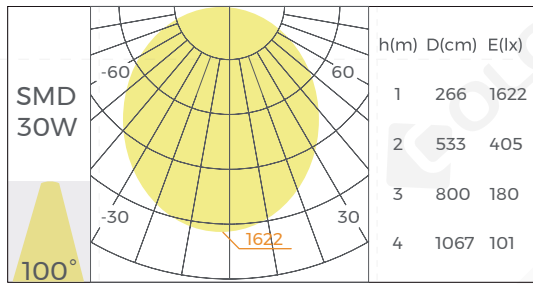

Regular version

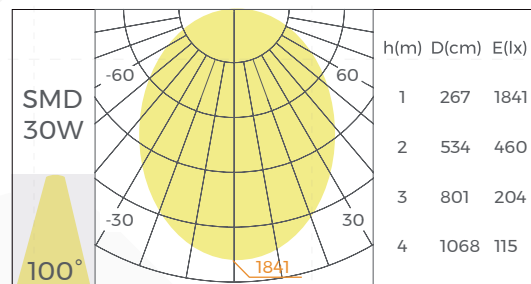

High-efficiency version

\*The above data is based on a 1200mm diameter module with Ra80,4000K.

### 【MS7035P-A90】

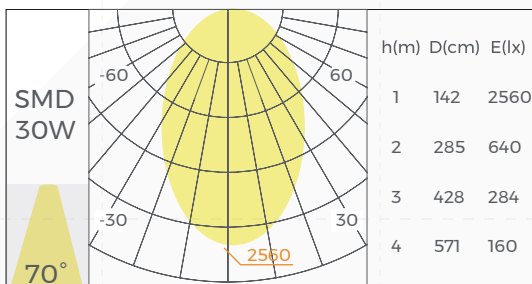

Regular version

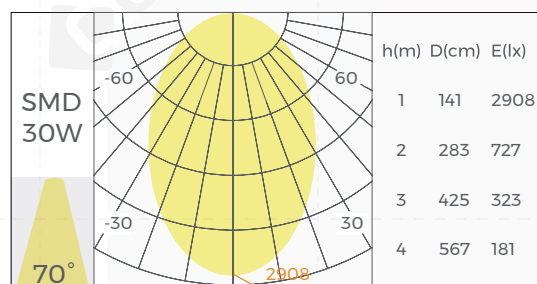

High-efficiency version

















\*The above data is based on a 1200mm diameter module with Ra80,4000K.

Note:





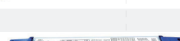



1. The above optical parameters refer to the Line series; only the light-emitting angle can be used as a reference.
2. For specific luminous effects, please use the report input DIALux software in the test report.





## © Common Accessories

### Power supply

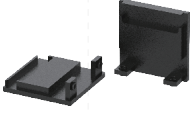
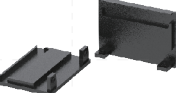
Picture	Dimming Method	Model	Input Voltage	Output Voltage	Output Current	Size(mm)	Certification
	NO/OFF	LF-GMR020YS0350H(S)	AC220 ~240V 50/60Hz	20-56V	0.2-0.35A	168*30*21	CCC/ENEC/CE/ RCM/UKCA
		LF-GMR040YS0700H(S)		20-56V	0.35-0.7A	210*30*21	
		LF-GMR040YS1050H(S)		20-38V	0.7-1.05A	210*30*21	
		LF-GMR060YS1550H(S)		20-39V	1.2-1.55A	280*30*21	
		LF-GMR060YS II		33-42V	1.15A	245*30*21	
		LF-GMR080YS II		33-42V	1.6/1.7/1.8 /1.9/2A	245*30*21	
	0-10V	LF-GLD025YE	AC220 ~240V 50/60Hz	25-42V	0.3/0.35/0.4 /0.45/0.5/0.55A	245*30*21	CCC/ENEC/CE/ RCM/UKCA
		LF-GLD035YE		25-42V	0.6/0.65/0.7 /0.75/0.8A	245*30*21	
		LF-GLD045YE		25-42V	0.85/0.9/1 /1.05A	245*30*21	
		LF-GLD055YE		25-42V	1.1/1.15/1.2 /1.3A	285*30*21	
		LF-GLD065YE		25-42V	1.35/1.4/1.5 /1.55A	285*30*21	
		LF-GLD080YE		25-40V	1.6/1.7/1.8/1.9/2A	355*30*21	
	DALI	LF-GSD020YE	AC220 ~240V 50/60Hz	25-42V	0.25-0.5A (50mA)	245*30*21	CCC/ENEC/CE/ RCM/UKCA
		LF-GSD030YE		25-42V	0.55-0.75A (50mA)	245*30*21	
		LF-GSD040YE		25-42V	0.8-1.05A (50mA)	245*30*21	
		LF-GSD060YE		25-42V	1.1-1.5A (50mA)	285*30*21	
		LF-GSD080YE		25-42V	1.55-2.0A (50mA)	355*30*21	

## Installation accessories

Picture	Name	Model	Description
	Ceiling	CL-28	2 pcs/set
	Pendant cable	PN-D	Steel Wire Rope: 2M Maximum weight capacity: 17.5Kg 2 pcs/set
	Pendant rod	PG-I	Rod Size: 1-2 meter adjustable
	Ceiling plate (Incl. wire)	PN-P	Ceiling Plate: D88*29mm Open hole: D75mm Maximum current capacity: 4A Maximum weight capacity: 3Kg Wire Size: D3*2000mm Suitable for MS3570/MS5070/MS7070/MS3535/MS5035/ MS7035 pendant input line
	Ceiling plate (Incl. rod&wire)	PG-P	Ceiling Plate: D88*29mm Open hole: D75mm Maximum current capacity: 4A Maximum weight capacity: 3Kg Rod Size: 1-2 meter adjustable Wire Size: D3*2000mm Suitable for MS3570/MS5070/MS7070/MS3535/MS5035/ MS7035 pendant input line
	Linear power Box (Incl. wire)	PB-07	Power Box: L400*W55*H50mm Maximum current capacity: 4A Maximum weight capacity: 8Kg Wire Size: D3*2000mm Suitable for MS3570/MS5070/MS7070/MS3535/MS5035/ MS7035 pendant input line
	Linear power box (Incl. rod&wire)	PB-08	Power Box: L400*W55*H50mm Maximum current capacity: 4A Rod Size: 1-2 meter adjustable Wire Size: D3*2000mm Suitable for MS3570/MS5070/MS7070/MS3535/MS5035/ MS7035 pendant input line
	Input line	CM-24	Wire Size: D3*2000mm Maximum current capacity: 4A Maximum weight capacity: 8Kg Suitable for MS3570/MS5070/MS7070/MS3535/MS5035/ MS7035 ceiling and MS3535/MS5035/MS7035 recessed input line
	End Caps	EC-MS3535	Material:AL6063-T5 Size:L35*W35*H2.5mm
	End Caps	EC-MS5035	Material:AL6063-T5 Size:L50*W35*H2.5mm

Picture	Name	Model	Description
	End Caps	EC-MS7035	Material:AL6063-T5 Size:L70*W35*H2.5mm
	Pendant cilps	CP-53	Material:SUS304 Size:L22.67*W20*H5.3mm Suitable for MS3535/MS3570 Pendant clips
	Pendant cilps	CP-54	Material:SUS304 Size:L37.87*W20*H5.4mm Suitable for MS5035/MS5070 Pendant clips
	Pendant cilps	CP-55	Material:SUS304 Size:L57.87*W20*H5.4mm Suitable for MS7035/MS7070 Pendant clips

Note:

1. The modules are manufactured with splicing accessories and terminals.
2. All standard modules can only use the power supply external solution, the above installation accessories for power supply external.

# Non-Directional Terminal Design

Non-directional terminal design that simplifies and enhances the efficiency of electrical connections between modules.

## ① Calculated Molding Current

Model Total Current

$$\frac{1A+0.5A+0.5A+0.5A+1A}{2A} = \frac{3.5A}{1.5A}$$

## ② Select Power Supply

**Drive**  
Output: 2A & 1.5A

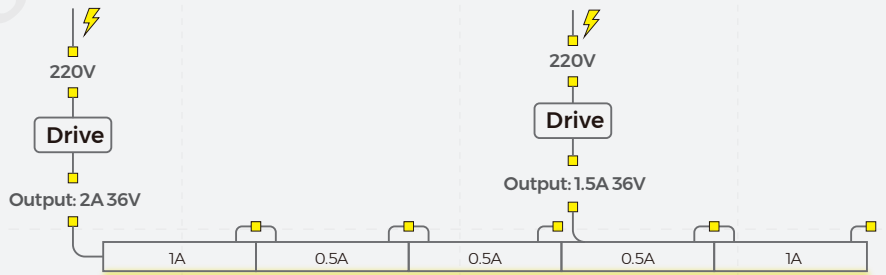

MAX CURRENT: 2A

The total current of the design should be consistent with the output current of the power supply

AC 220V



Non-directional

Note:

1. The above electrical connection modeling is a 35mm luminaire height demonstration only to show the non-directional terminal design.
2. The above graphic explains how to select the right power supply by calculating the current



## ◎ Packing













Model	Quantity (/inner box)	Quantity (PCS/carton)	NW (kg/carton)	GW (kg/carton)	Size (mm/carton)
MS3535DD0450A90(R) -X840W006	1	6	1.70	5.40	380*300*260 [14.96"*11.81"*10.23"]
MS3535DD0600A90(R) -X840W009	1	6	2.26	6.24	480*300*260 [18.89"*11.81"*10.23"]
MS3535DD0800A90(R) -X840W012	1	6	3.01	7.20	620*340*260 [24.40"*13.38"*10.23"]
MS3535DD1000A90(R) -X840W015	-	6	3.77	8.10	770*420*260 [30.31"*16.53"*10.23"]
MS3535DD1200A90(R) -X840W018	-	6	4.52	9.00	920*500*260 [36.22"*19.68"*10.23"]
MS3535DD1500A90(R) -X840W024	-	6	5.65	10.80	1120*580*260 [44.09"*22.83"*10.23"]
MS3535DD2000A90(R) -X840W032	-	6	7.54	12.60	1400*380*500 [55.11"*14.96"*19.68"]
MS3535DD3000A90(R) -X840W047	-	6	11.30	15.00	2180*520*500 [85.82"*20.47"*19.68"]
MS5035DD0450A90(R) -X840W007	1	6	2.01	6.00	380*300*260 [14.96"*11.81"*10.23"]
MS5035DD0600A90(R) -X840W011	1	6	2.68	6.60	480*300*260 [18.89"*11.81"*10.23"]
MS5035DD0800A90(R) -X840W014	1	6	3.58	7.50	620*340*260 [24.40"*13.38"*10.23"]
MS5035DD1000A90(R) -X840W018	-	6	4.47	8.40	770*420*260 [30.31"*16.53"*10.23"]
MS5035DD1200A90(R) -X840W022	-	6	5.37	9.60	920*500*260 [36.22"*19.68"*10.23"]
MS5035DD1500A90(R) -X840W028	-	6	6.71	11.40	1120*580*260 [44.09"*22.83"*10.23"]
MS5035DD2000A90(R) -X840W036	-	6	8.95	13.20	1400*380*500 [55.11"*14.96"*19.68"]

Model	Quantity (/inner box)	Quantity (PCS/carton)	NW (kg/carton)	GW (kg/carton)	Size (mm/carton)
MS5035DD3000A90(R) -X840W053	-	6	13.42	17.40	2180*520*500 [85.82"*20.47"*19.68"]
MS7035DD0600A90(R) -X840W014	1	6	3.25	6.60	480*300*260 [18.89"*11.81"*10.23"]
MS7035DD0800A90(R) -X840W022	1	6	4.33	7.80	620*340*260 [24.40"*13.38"*10.23"]
MS7035DD1000A90(R) -X840W024	-	6	5.42	10.20	770*420*260 [30.31"*16.53"*10.23"]
MS7035DD1200A90(R) -X840W030	-	6	6.50	11.40	920*500*260 [36.22"*19.68"*10.23"]
MS7035DD1500A90(R) -X840W038	-	6	8.12	12.60	1120*580*260 [44.09"*22.83"*10.23"]
MS7035DD2000A90(R) -X840W049	-	6	10.83	14.40	1400*380*500 [55.11"*14.96"*19.68"]
MS7035DD3000A90(R) -X840W075	-	6	16.25	21.00	2180*520*500 [85.82"*20.47"*19.68"]

Note:

1. The above weight data is for reference, the exact data should be based on the weight of the physical weighing shall prevail.
2. Only the D450/D600/D800 sizes use the inner box packaging.

## Model Code

<b>M</b>	<b>S</b>	<b>3535</b>	<b>D</b>	<b>D1200</b>	<b>A90</b>	<b>(R)</b>	-	<b>X</b>	<b>8</b>	<b>40</b>	<b>B</b>	-	<b>O18</b>
 Type M: Module	 Installation E: Recessed S: Ceiling/Pendant	 Size 3535: Surface width of module 35mm: Height of module	 Optical Type D: Diffuser P: Prismatic	 Diameter D1200: 1200mm	 Corner Angle A90:90°	 Version (R): Regular (H): High-efficiency	-	 Dimming Method X: No power N: Non-dimming D: 1-10V A: DALI	 CRI 8: Ra>80 9: Ra>90	 CCT 27: 2700K 30: 3000K 40: 4000K	 Color B: Black W: White S: Silver	-	 Type power O18: 18W

## Attentions

1. Non-professionals are prohibited from installing, disassembling and repairing the product.
2. Avoid scratching, distortion and irregular bending of the product during installation; otherwise it may cause irreparable damage to the product.
3. Please use professional cutting tools when cutting
4. Do not use any acid or alkaline adhesive to fix products
5. The product is only suitable for indoor dry places, can not be used in outdoor, seaside or wet environment.
6. PC features: Each 10°C rise or drop will make diffuser extend or shrink 0.8mm/m, please confirm before processing and use